

60" Easy Table

DESIGNED IN 2016

ASSEMBLY NOTES | REV 03

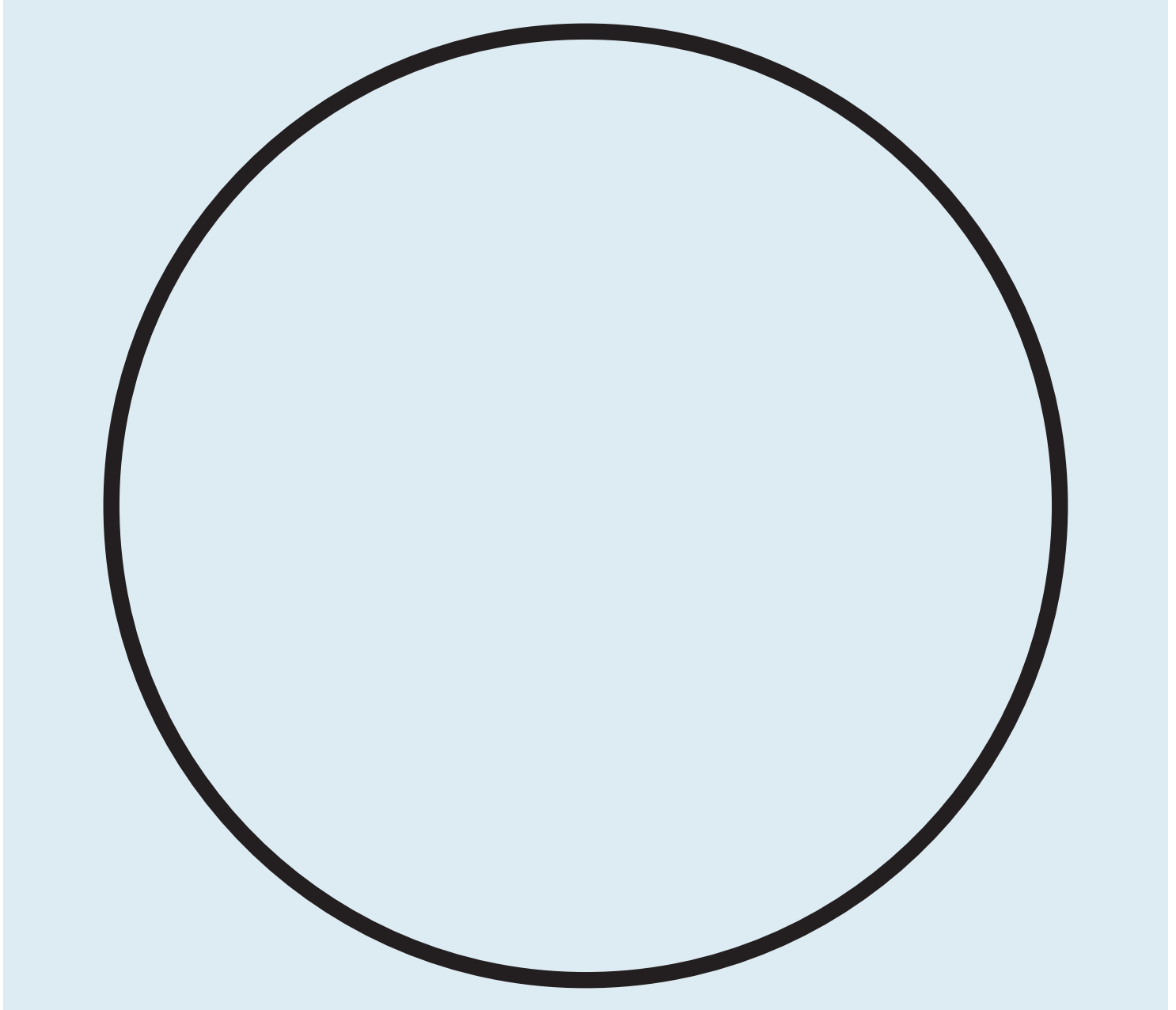

EASY DOES IT.

Breakfast, lunch, dinner or whatever. An uncomplicated pairing of a beefy steel pedestal and a warm walnut or white oak top.

NEED A HAND?

Contact us at service@bludot.com or **844.425.8368** for assistance.

Parts & Hardware

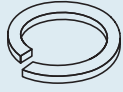

QTY 8

Pt. 3003

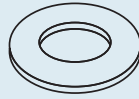

QTY 8

Pt. 3004

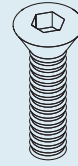

QTY 8

Pt. 1056

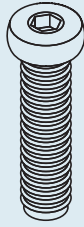

QTY 8

Pt. 1075



QTY 1

Pt. 9001

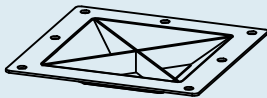

QTY 1

Metal Plate

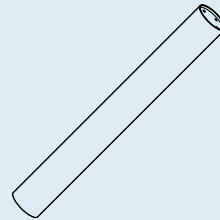

QTY 1

Support

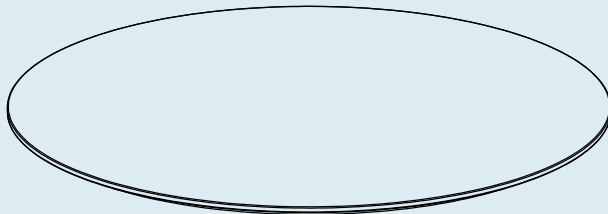

QTY 1

Top Panel

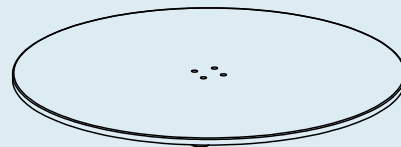

QTY 1

Base Plate

Step 01

ATTACH METAL PLATE TO SUPPORT.

Attach the metal plate to the upright as shown using the provided hardware.

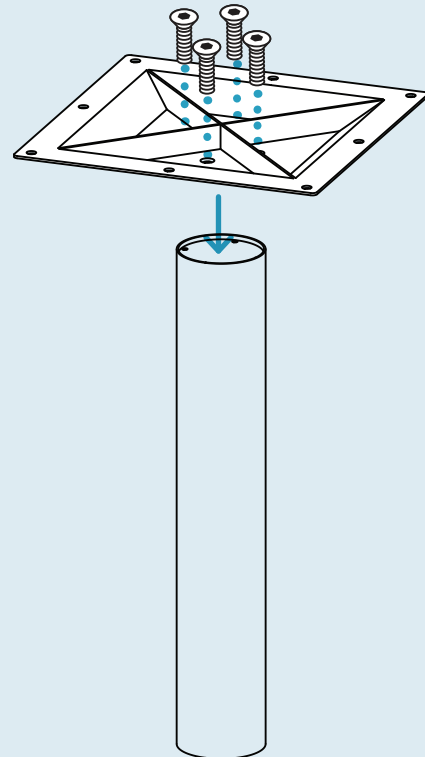
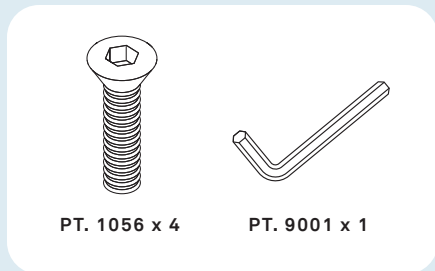

Step 02

ATTACH BASE PLATE TO SUPPORT.

Attach the base plate to the upright as shown using the provided hardware.

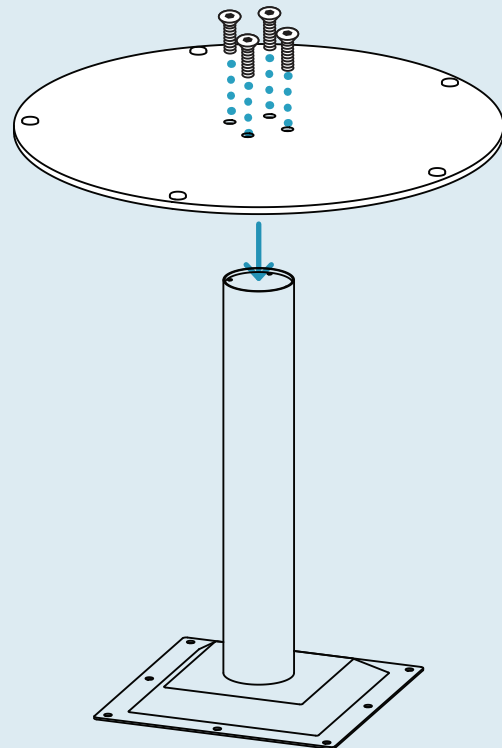
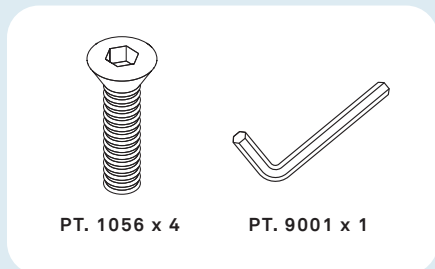

Step 03

ATTACH TOP.

Attach the top panel as shown using the provided hardware.

Note: Use pre-attached adjustable feet to level the table prior to first use.

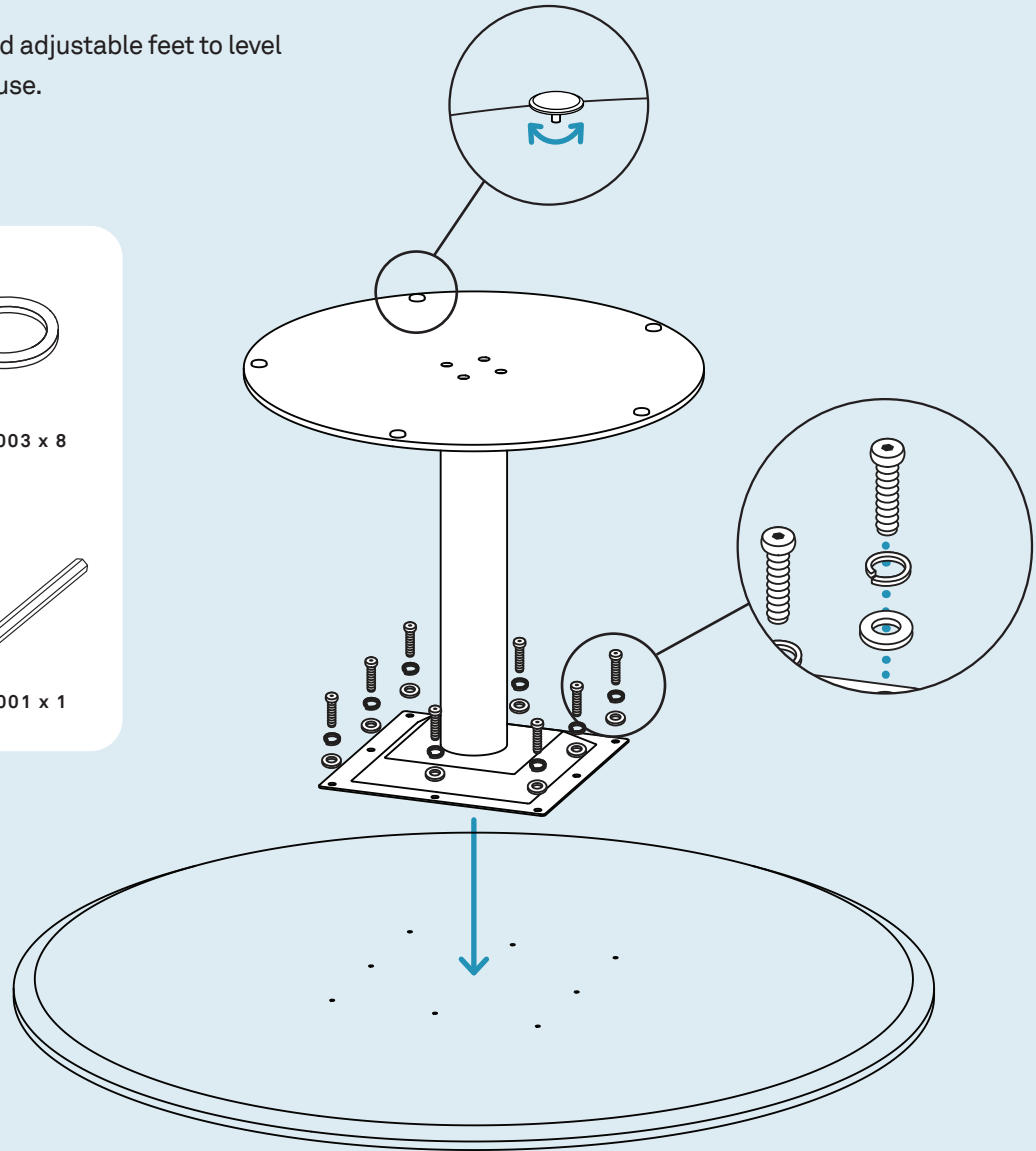
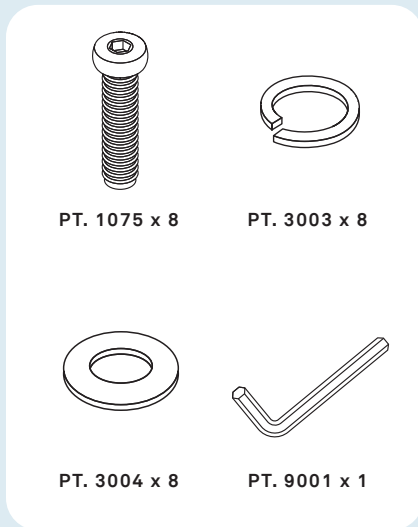

Additional Information

CLEAN

Clean with a slightly damp, soft cloth. To remove dirt and fingerprints, use a quality cleaner formulate for wood furniture. Wipe completely dry with a soft cloth in the direction of the wood grain.

